

How a Font Can Respect Basic Rules of Arabic Calligraphy

Abdelouahad BAYAR
Ecole Supérieure de Technologie - Safi
Cadi Ayyad University
Dar Si Aissa Road, P.O.B 89, Safi 46000
Morocco
bayar@ucam.ac.ma

Khalid SAMI
Faculty of sciences - Marrakech
Cadi Ayyad University
12 BD. My Abdellah, P.B 2390, Marrakesh 40000
Morocco
k_sami@ucam.ac.ma

Abstract This paper describes formal bases for designing a PostScript dynamic font respecting some basic rules of Arabic calligraphy. This font will provide, for instance, a vertical curvilinear characters dynamic stretching that depends on their horizontal stretching according to the Calligraphic rules. Vertical and horizontal ligatures will also be supported by the proposed font. The techniques used can be applied in various digital typography contexts such as in typesetting mathematics, to get big delimiters for instance. The results presented here give both extensions and corrections of some already adopted techniques.

Keywords: Dynamic Font, Curvilinear Stretching, PostScript, Complex ligatures.

1. Introduction

Processing documents written in an Arabic alphabet-based script is not an easy business. For instance, in order to justify texts, stretching characters replaces the ordinary inserting spaces between characters. This stretching is almost mandatory in a cursive writing such as Arabic. Systems such as Arab \TeX [18] or Ω [31] can help in typesetting a quite complex Arabic documents, say for example mathematical texts, in a quite good quality. However, most of the software designed for typesetting documents based on this script don't take sufficiently into account the complex rules of characters stretching. The CurExt [5] system provides some solutions for dynamic fonts and extensible symbols in Arabic mathematical formulas. So, it gives, by the way, solutions for the composition of the Arabic keshideh (a small flowing curve stretching characters in Arabic-alphabet based scripts). This package combined to RydArab [4] run with both Arab \TeX or Ω and provides support for the composition of right to left mathematical equations based on Arabic symbols.

Actually, the stretching of characters according to the Arabic calligraphy rules requires that the fonts development languages support what can be called '*fonts dynamic*' as PostScript language does [2]. Unfortunately, this support is not offered by Metafont [10] the first system used for developing \TeX 's fonts. The CurExt system generates curvilinear stretching of Arabic characters through repeated calls of Metafont. The D. Berry



Figure 1. The written (in black) and the drawn (non totally black) parts of the standalone REH (scanned from [14]).

system [8] also offers the possibility of characters *horizontal stretching* up to some level. However, the Arabic calligraphy rules require a *vertical stretching* also.

In Arabic calligraphy, some parts of the letters are *written*, directly with the nib's head, and other parts are *drawn*: the contour is set first, with the right up corner of the nib's head (the qalam's tooth) and therefore, it is darkened as with a brush [3, 22, 25]. The figure 1 presents a letter REH where the written part is in black and the drawn part, to be darkened, in a different gray. This figure comes from the calligraphy handbook [22]. This fact is due to the rectangular shape of the nib's head and to its constant inclination with respect to the vertical direction. Such considerations are not to take into account in traditional typography. Most of the pens have a circular head and they can go with any inclination. In the proposed font, the written parts would be shaded

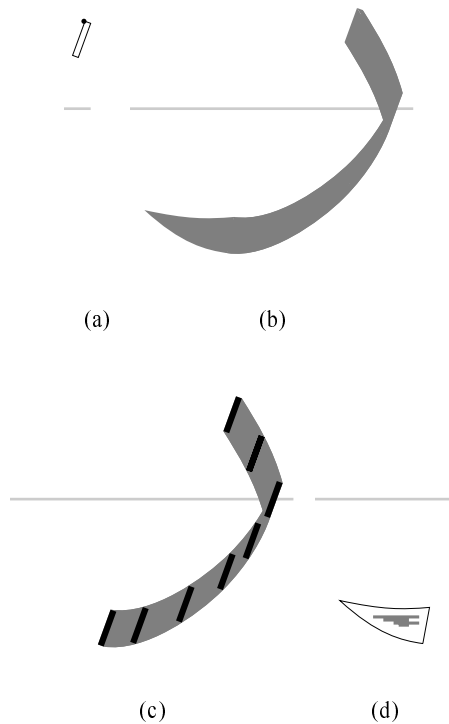

Figure 2. a) The nib's head in 192 points, b) The standalone REH in 192 points, c) The written part of the Letter REH in 192 points, d) The drawn part of the letter REH in 192 points.

through considering the nib's head *motion* (see later) and the drawn ones are considered as simple contours to darken. The figure 2 shows the standalone REH in our font in 192 point size. The figure 2(a) presents the nib's head in the size 192 points for the Naskh style. The corner marked with a solid circle models the part of the nib's head used by a calligrapher to blacken the drawn parts of letters. The standalone REH is given on 2(b), in the same size. The written and the drawn parts are showed in the figure 2(c) and 2(d) respectively. Some states of the nib's head motion are given on the written part of the letter REH. One important thing to underline is that the surface in the written part never exceed the width of the nib's head nor it is exceeded by the nib's head width (kept at 70° inclination). The standalone REH implemented in the font is slightly different from the one presented in the figure 1 because the letter scanned and used to determine the encoding of the letter REH in the font comes from another calligraphy book [3].

In [8], particular curves for representing stretchable pieces of the characters were to find out. The approach adopted in [8] to stretch letters can lead sometimes, to write some parts of the letter, in a width exceeding, or exceeded by, the nib's head width. See, for instance, the stretched QAF in [2, p.1433] (see the figure 3). The figure 3 presents the letter QAF with a null stretching and a stretched QAF from [8] (a slightly different variant from

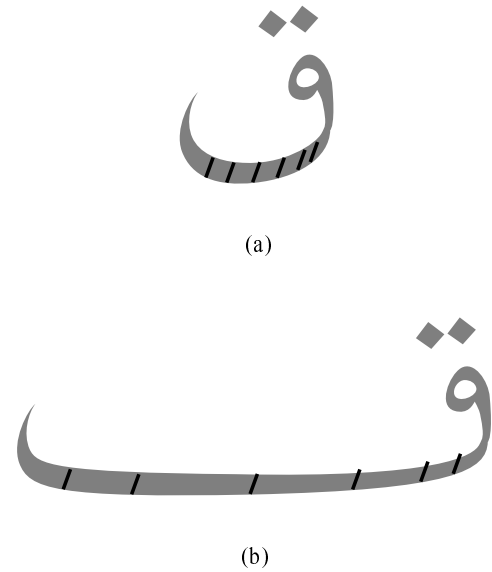

Figure 3. a) The standalone QAF in Daniel Berry font, b) A stretching of standalone QAF in Daniel Berry font.

the same letter). We tried to show the same states (for the same parameters of the Bézier curves representing the contours) of the nib's head in the two cases of the letter QAF. We remark that in 3(a), the width of the nib's head is approximately equal to the surface. The letter QAF with a null stretching is a genuine *written* QAF. In the stretched QAF (see figure 3(b)), on the right, the nib's head width exceeds largely the surface darkened of the letter and conversely on the left of the same letter. So, some parts that are written in the null stretching case can not be obtained when the letter is stretched unless they are *drawn*. This is due to the curves to stretch choice. Actually, these curves should verify a dependency property since they represent trajectories of two corners of the nib's head following the same movement with respect to a translation (take into account the motion in shading the surface razed with the nib's head).

A significant progress in the development of Arabic mathematical dynamic fonts has been presented in [27]. A type 3 PostScript font has been developed for the purposes of CurExt in order to produce documents respecting the Arabic calligraphy rules and allowing the support of stretchable mathematical symbols. In CurExt, the variable sized character, in the suitable size, is produced via repeated calls of the program. Although our *dynamic* type 3 PostScript font aims at producing variable sized characters too, the approach adopted is different. The dynamic is inherent to the font, not in the font generator. The stretching's encoding is not the same. Moreover, some proposed modules can be integrated into certain typesetting systems such as L^AT_EX [21]. The text displayed in screen fonts will be used with these formatting mod-

ules through the parameters of pagination and the font would help in generating directly a PostScript document respecting the rules of Arabic calligraphy.

In Arabic calligraphy, some kinds of ligatures are mandatory and others are only for aesthetic. All of the systems cited before use fonts providing some mandatory ligatures such as the horizontal ligatures exactly on the baseline and some vertical ligatures for aesthetic. However, there are other not provided mandatory and also aesthetic ligatures like oblique, big strictly above the baseline, strictly above the baseline and horizontal below the baseline ligatures. Those ligatures are studied in the paper.

We'll begin by presenting the curvilinear stretching in Arabic calligraphy. This will lead to some general Arabic calligraphy constraints. Then, we will focus on ligatures, their categories and kinds. The support of the keshideh can then be formalized in mathematical model, implemented in a font and thus compared to other approaches.

2. Curvilinear stretching in Arabic calligraphy

2.1 Stretching in Arabic Calligraphy

As it has been mentioned before, the keshideh is a small flowing curve that stretches characters or junctions between characters in Arabic-alphabet based scripts. It is used, for instance for justification. So, instead of inserting spaces (blanks) between words, characters and/or ligatures are stretched according to a structured set of calligraphic rules. More rules of justification in Arabic documents can be found in [26]. In that paper, the authors present most of the existing methods of justifications especially the keshideh. In our article, we give a method to implement the keshideh in a PostScript font. This stretching goes in both the horizontal and vertical directions. Horizontal curvilinear stretching can go to a maximal value of 12 diacritic points. To this horizontal maximal value corresponds a maximal vertical stretching of a half diacritic point downwards. Moreover, we can distinguish two kinds of stretching :

- Stretching the ligature between two connected letters and
- Stretching inside a letter.

For instance, consider the words presented in figure 4. The first line displays the word ظفر with three extensions, zero, 6 and 12 diacritic points (from right-to left). The keshideh takes place between the letters َ and ِ. In the following line, the word حق is stretched with zero, 9, 11 and 12 diacritic points. Then, the stretching is performed inside the last letter QAF ق. In the calligraphy

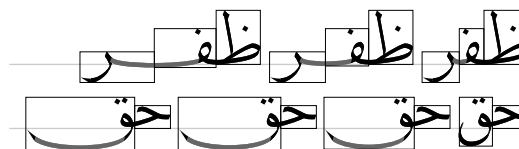

Figure 4. Two curvilinear stretchings in Arabic calligraphy

books [3, 22, 25], the letter QAF without stretching is different from the stretched one. That is also true for all letters that undergo stretching inside them. This property hadn't been respected in [8] (see figure 3 and 4 to compare). In the figure 4, the keshideh is darkened in Gray and the boxes are reproduced for more clarity. Most of Arabic letters, are composed in two parts. One is static and an other that is dynamic. The dynamic part is the set of curves that undergo really the stretching. As example, we have to look to the letter َ on the figure 4. The static part is in black whereas the dynamic one is in Gray.

2.2 Dynamic fonts and the support of stretching

The *stretching amount* is the difference between the length of the current line and the sum of the lengths of the words added to the sum of the normal blanks (a normal blank is the minimal blank used to separate normally two words). This stretching amount depends on the line context. A good font to support the stretching may allow continuous variations in stretching. We have here the same need in type of font like in [8, 13, 14]; a dynamic font.

2.3 Implications for the design of the font

A font with a good support for the stretchability may be based on a language that provides the possibility to use variables in character procedures that can be computed on the fly (dynamically). Postscript dynamic fonts [12] and TrueType fonts [11] are examples of such kind of fonts. As we are here extending and improving what has been done in [8], we will rather opt for PostScript. The PostScript fonts of type 3, as proposed in [12] use the full PostScript language and violates the assumption for the type 1 fonts [1], namely the printing in a fast way thanks to the concept of catching the character bitmaps for ulterior usage, the ability to provide hints to improve low resolution or small point size rasterization and also the ability to be handled by the Adobe Type Manager (ATM). Here I agree with the opinion of the author of [8] that the beauty of what can be done with dynamic fonts, and so write an Arabic text with the keshideh outweighs the disadvantages.

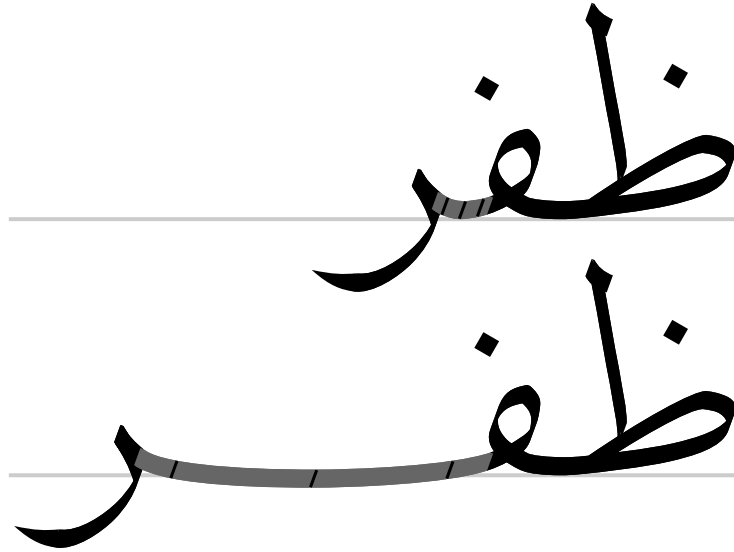

Figure 6. The optical scaling characteristics of the Arabic curvilinear stretching

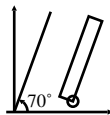

Figure 5. Nib's head in Naskh style with 12 mm width

2.4 Characteristics of the stretching in Arabic Calligraphy

In the Naskh style, the nib's head behaves as a rectangle of width l and thickness $e = \frac{l}{6}$. This rectangle moves with a constant inclination angle of about 70° with regard to the baseline. A nib's head with $l = 12$ mm (and $e = 2$ mm) is presented in the figure 5.

As mentioned before, the stretching goes in both the horizontal and vertical directions. In addition, the stretching ought respect the following constraints :

- The horizontal stretching can go from 0 to 12 diacritic points (the dot \cdot in the letters ظ and ز is a diacritic point and it can be used as a metric unit).
- The vertical stretching depends on the horizontal one and varies from 0 to half of a diacritic point. The stretching model provided in [8] considers stretching only in the horizontal direction.
- In the connection of two stretched zones, the state of continuity of degrees 0 and 1 is preserved. This will be well explained through considering the Bézier geometrical representations. Prematurely, the reader can see the figures 41 and 46. The set of curves in the figure 46 is obtained after a stretching in the set of curves in the figure 41. We can remark

that the angle on the point L_{10} is conserved on L_{20} and the alignment on R_{13} is conserved on R_{23}

In the figure 6, The word ظفر is presented with a null stretching in the first line, whereas, in the second line the same word is displayed with an horizontal stretching of 12 diacritic points and the corresponding vertical stretching that is a half of a diacritic point. The nib's head (in black) appears in the gray of the keshideh. We can remark that the thickness (in the direction of the nib's head inclination) doesn't change and consequently, the stretching model is an optical scaling in opposition to the linear scaling (see [14] about optical scaling). In the following, the stretching model is presented in the same way.

Let us look at the relationship between the external curves delimiting the surface razed with the nib's head. We have to darken the surface taking into account this relationship. That has not been considered in [8]. And now, we'll consider that :

The character is defined by the curves representing the nib's movement not by those representing the limits of the surface razed with the nib.

This means that a character results from blacking the surface razed with the rectangle representing the nib's head. As the four corners of the nib's head follow the same movement, the movement can be represented by the curve corresponding to the way followed by one of the four corners. Say for instance, the extremity surrounded with a small circle in the figure 5. Of course, the movement of this corner when writing a character is determined by a set of Bézier curves. So, we'll consider a unique Bézier curve.

Let B_1 be a Bézier curve with the four control points

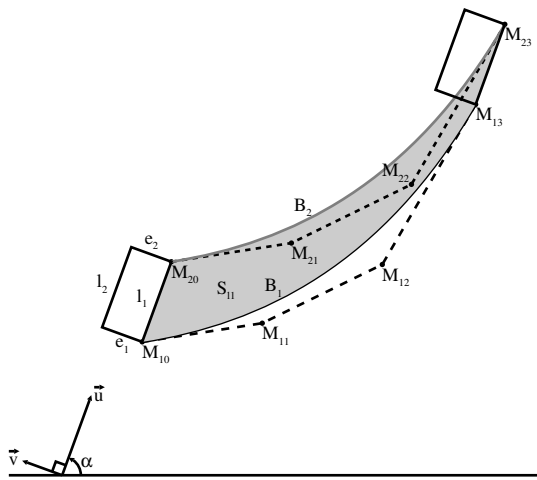

Figure 7. Surface razed with the edge l_1 (thin gray)

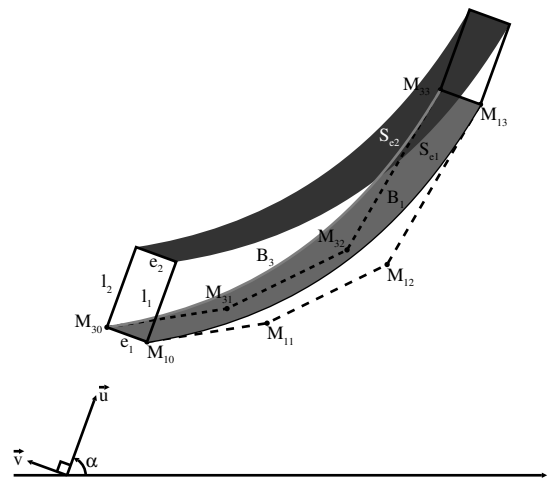

Figure 9. Surfaces razed with the two edges e_1 and e_2

M_{10} , M_{11} , M_{12} and M_{13} (see figure 7), the curve B_1 represents the movement of the right bottom corner of the nib. Width, thickness and inclination angle of the nib are respectively denoted by l , e and α .

Consider B_2 , the Bézier curve with the four control points M_{23} , M_{22} , M_{21} and M_{20} such that : $M_{2i} = t_{\vec{u}}(M_{1i})$, $i \in \{0, 1, 2, 3\}$ where $t_{\vec{u}}$ is the translation of vector \vec{u} such that $\vec{u} = (l \cos(\alpha), l \sin(\alpha))$.

The surface S_{l1} delimited by the curve B_1 , the segment $[M_{13}, M_{23}]$, the curve B_2 and the segment $[M_{20}, M_{10}]$ coincides exactly with the surface razed by the edge l_1 . The surface is filled in thin gray in the figure 7.

The surface S_{l2} razed by the edge l_2 can be obtained through translating the surface S_{l1} with vector $\vec{v} = (l \cos(\alpha + \frac{\pi}{2}), l \sin(\alpha + \frac{\pi}{2}))$ (see figure 8).

Let $S_{l2} = t_{\vec{v}}(S_{l1})$ be the result of this translation.

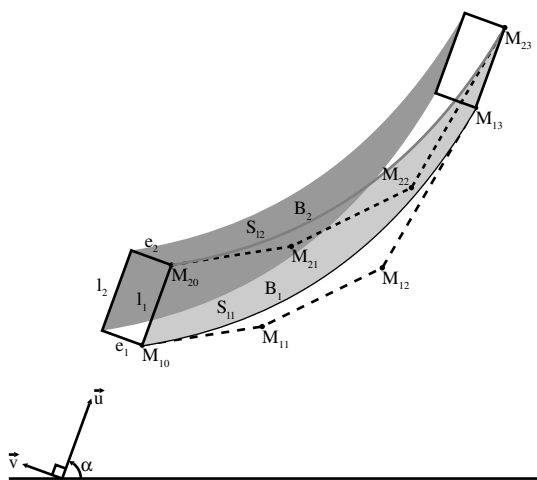

Figure 8. Surface razed with the edge l_2 (little dark gray)

to get the whole surface razed with all the nib's head, the surfaces S_{e1} and S_{e2} are also to be taken into account (see figure 9) so that we get :

S_{e1} : surface bounded by B_1 , $[M_{13}, M_{33}]$, B_3 and $[M_{30}, M_{10}]$, that is the surface razed by edge e_1 .

B_3 : a Bézier curve with control points M_{33} , M_{32} , M_{31} and M_{30} so that :

$M_{3i} = t_{\vec{v}}(M_{1i})$, $i \in \{0, 1, 2, 3\}$, and

$S_{e2} = t_{\vec{v}}(S_{e1})$.

These four surfaces allow the reconstitution of the surface razed by the nib's head. The figure 10 shows an illustration of this situation. It gives the control points of the Bézier curve modeling the movement of the left bottom corner.

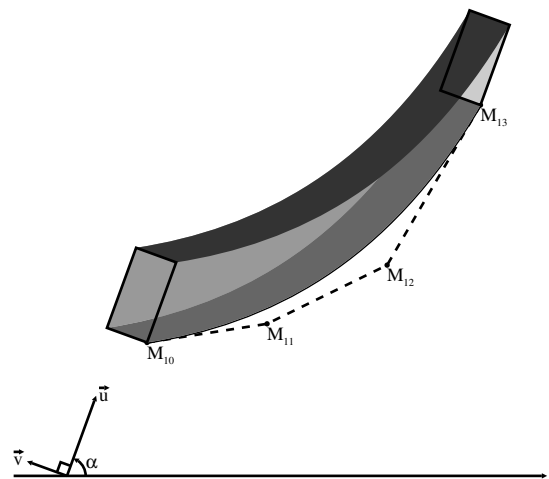

Figure 10. Surface razed with all the nib

This way of blacking the surface razed by the nib does not give always good result. Actually, consider the example on the figure 11. In order to simplify, consider a nib with a very thin head (with negligible thickness). The surface obtained through applying the technique used previously (see figure 11) does not coincide exactly with the surface razed with that nib (see figure 12). The geometric reason why it is so is the existence of an element $t_0 \in]0, 1[$ such that $B'_1(t_0)$ ($B'_1(t_0)$ is a vector) and the

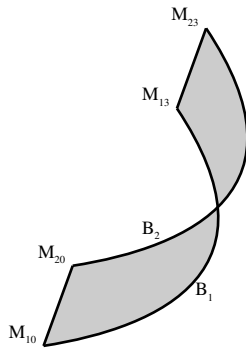

Figure 11. The result of filling in the surface between the two curves with the previous technique

vector $\overrightarrow{M_{10}M_{20}}$ are collinear (such condition was not satisfied in the case of the previous examples). More formally, consider the function R_1 defined as follows :

$$R_1 : [0, 1] \rightarrow \mathbb{R}$$

$$t \mapsto \left(\overrightarrow{M_{10}M_{20}} \wedge \overrightarrow{OB_1(t)} \right) \cdot \vec{k}$$

when the considered Bézier's curves are defined on the affine plane \mathbb{R}^2 reported to the orthonormal basis $R(O, \vec{i}, \vec{j})$ containing the origin O and that is a subspace of the affine space \mathbb{R}^3 with the orthonormal basis $R(O, \vec{i}, \vec{j}, \vec{k})$ and the operator \wedge stands for the vectorial (cross) product.

$R_1(t)$ is the direct orthogonal range of the Bézier curve B_1 according to the vector \vec{k} . if $R_1(t)$ is null at $t_0 \in]0, 1[$, that means that $B'_1(t_0)$ and $\overrightarrow{M_{10}M_{20}}$ are superposed. As that $R'_1(t) = \left(\left(\overrightarrow{M_{10}M_{20}} \wedge \overrightarrow{OB_1(t)} \right) \cdot \vec{k} \right)'(t) = \left(\overrightarrow{M_{10}M_{20}} \wedge B'_1(t) \right) \cdot \vec{k}$, we get the interpretation :

- if R_1 is monotone on an interval $[0, 1]$ then the razed surface can be obtained through applying the method mentioned before,
- the method fails if the monotony's sense of R_1 changes.

We can remark that the study of the function R_1 can help to blacken the surface razed in the figure 12. The curve B_1 is a perfectly determined Bézier curve. The study of R_1 over $[0, 1]$ shows that R_1 admits an extrema at $t_0 = 0.6184$ and the monotony's sense doesn't change over the sub-intervals $[0, 0.6184]$ and $[0.6184, 1]$.

Now, let us decompose B_1 with respect to the generalized Bézier algorithm of refinement (case of none median decomposition) [7, 15, 23, 29] with respect to the coefficient $t_0 = .6184$. So we'll get two curves B_{11} and B_{12} whose corresponding razing can be obtained

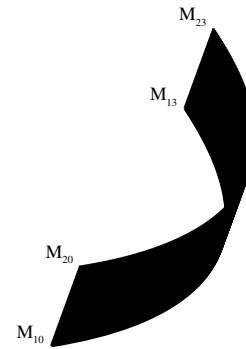

Figure 12. Surface razed with the nib

through proceeding as in the example in figure 7. The two razings are on the figures 13 and 14.

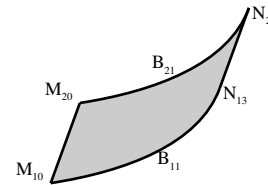

Figure 13. Surface razed over $[0, 0.6184]$

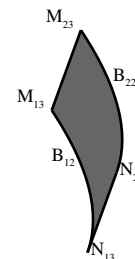
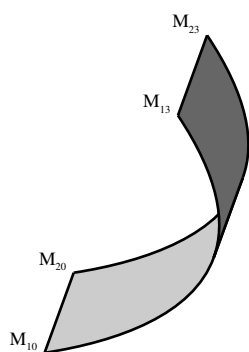

Figure 14. Surface razed over $[0.6184, 1]$

The two surfaces overlap and reconstitute a surface that fit exactly with the surface razed with the segment $[M_{10}M_{20}]$ (see figure 15). This way of proceeding can be very useful for the design of characters shapes in PostScript or Metafont so that the trajectories of the sum-mits nib overlap.

The difficulties to find out a way to represent and to *coat* the nib's head movement reminds those met in the knuth's approach in metafont [10] or those found in the kinch's approach in MetaFog [28]. The comparison will be considered in the sub-paragraph 4.3

Figure 15. Superposed razed surfaces on $[0, 1]$

3. On some Arabic calligraphy constraints

3.1 The notion of baseline

The baseline is one of the basic notions in digital typography [9, 30, 10, 2]. It constitutes the basic reference for positioning the characters, or symbols in a mathematical formula and so on. In Arabic writing normative studies, there is no general agreement on the necessity of this reference. Some calligraphers think that the notion of baseline is meaningless. Others think that its position is not steady [27]. Nevertheless, the reference to the baseline can be very helpful and even necessary for positioning signs. Actually, some parallelism among words and even among letters, with regard to a virtual horizontal line, can be noticed in any written line. We will use the common methodology related in the A. El Husseiny's calligraphy's book [3] to define the baseline used in the development of a Naskh font providing the possibility of characters curvilinear extension. According to this reference, two groups of isolated Arabic letters may be distinguished: those to place above the baseline and those containing pieces above and/or below the baseline (see figure 16).



Figure 16. Isolated letters in Naskh style with respect to the baseline



Figure 17. Three different Arabic letters resulting from the diacritic dot use or position



Figure 18. Metrics of the letter HAH in the calligrapher way

3.2 Arabic calligraphic metrics

The measure unit in Arabic Calligraphy is the diacritic dot used to differentiate some Arabic letters with the same shape. For example, the letters HAH, JEEM and KHAH (from the right to left), in initial position, are presented in the figure 17. The diacritic point is the small square filled in thin gray. The same dot is the measure unit used to define the letters dimensions. In the Naskh style, the diacritic point is a filled in square with sides of a width equal to the width of the nib's head and rotated about 60° . In the figure 18, some metric indications to write the letter HAH (in the initial form with oblique ligature) are in charge of the diacritic dots. In calligraphy, the space between two consecutive dots in a measure is about 0.45 to 0.5 of a *calligraphic* dot. But, in our work, all the metric values are given in terms of *diacritic points*, without spaces (see figure 19). In the figure 19, an example of a stretching of the word ظفر is presented. The first line displays the word ظفر with the keshideh in gray in its initial size i.e with a null stretching, the width's keshideh is two diacritic points and a fraction. In the following line, the same word is stretched 12 diacritic points horizontally. To the horizontal stretching corresponds a vertical stretching of half a diacritic point downwards with respect to the baseline (see later for the rules of stretching). We can also get information about metrics from [26].

3.3 Connections and ligatures

The Arabic writing is cursive. The notion of ligature is of a particular importance. Handling ligatures in Arabic is of a strong complexity in comparison with Latin alphabet based scripts. Now, let us give some details on *connections* of letters since they are the bases of the ligatures. In Arabic calligraphy, a connection is a fine curve following the nib's head inclination that connects a letter to another before or after it. So, we can talk about

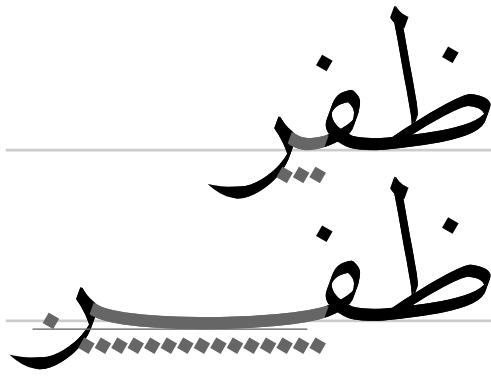

Figure 19. A stretching of 12 diacritic points horizontally and 0.5 vertically

preceding and succeeding connections (see figure 20 and 21). In the sequel, categories and examples of connections are given. Actually, two categories of connections can be distinguished, namely :



Figure 20. In gray, succeeding connection of the letter KHAH in initial position



Figure 21. In gray, preceding connection of the letter TAH in final position

- *Horizontal connection* : horizontal connections can be regarded as tools to tie letters so that the boxes containing these letters are horizontally positioned. In the figure 20 and 21 are showed the horizontal succeeding connection of the letter KHAH and the preceding connection of the letter TAH respectively. The connections are in thin gray. In the figure 22, the word *خط* formed of the letters *خ* and *ط* with their digital boxes is presented. So, the definition of the horizontal connection is more clear.

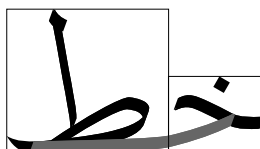

Figure 22. Boxes position with vertical connections

- *Vertical connection* : a vertical connection allows connecting two letters so that their boxes can be positioned vertically (see figure 25). The figure 23 and 24, displays the succeeding and preceding connections of the two letters NOON and HAH.



Figure 23. In gray, vertical succeeding connection of the letter NOON in initial position



Figure 24. In gray, vertical preceding connection of the letter HAH in median position



Figure 25. Boxes position with horizontal connections

When they are in the middle of the word, some Arabic letters can have both a succeeding connection and a preceding connection at the same time. For instance, consider the letter *ظ* in the middle of the word *ظفر* (see the figure 26).

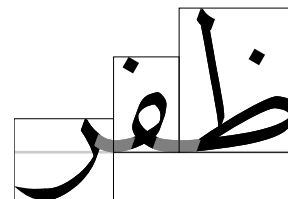

Figure 26. An Arabic letter with a succeeding and preceding connections

We define a *ligature* as a set of one or more pair of connections. A pair of connections is composed of a succeeding connection and a preceding one. There are two categories of ligatures namely :

- *Horizontal ligature* : it is a combination of an horizontal succeeding connection and an horizontal preceding one. In the figure 22, the ligature between the letters KHAH in initial position and TAH in final one of the word *خط* is an example of such ligature.

- *Vertical ligature* : it is a set of pairs of vertical connections. Every pair is formed of a vertical succeeding connection and a vertical preceding connection. In the figure 25, a vertical ligature appears between the letters NOON and HAH. It contains one pair of vertical connections. It is then a simple vertical ligature. In the figure 27, the ligature is composed of two pairs of connections connecting the letter LAM to MEEM and MEEM to JEEM. The ligature is then double. Whereas, on the figure 28, the ligature connects four letters and thus is formed of three pairs of vertical connections. It is a triple ligature.

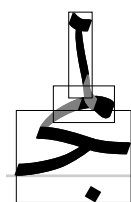

Figure 27. Double vertical ligature



Figure 28. Triple vertical ligature

Some difficulties occur in handling vertical ligatures. Solutions can be found through considering the connected letters as a single character [30]. We'll adopt the same strategy concerning this kind of ligature. We will refer to those characters as compound letters. In this way, the compound letters are considered as single characters with horizontal preceding connections, horizontal succeeding connection or both of the two connections. They can also be considered as standalone letters. All of these cases are presented in the figure 30. So, the compound letters can accept preceding or succeeding connections or contribute simply as standalone characters in words (see figure 31). They can also contribute in stretching (see figure 29).

We can remark that the handling of vertical ligatures can be brought to the study of the horizontal ligatures. For that reason, we will give in the following all kinds of horizontal connections and ligatures. We have seen in the subsection 2.4 that the movement of the nib's head is characterized by one of its corners. We present then the kinds of connections and ligatures in their geometrical forms through considering the trajectory of the left bottom corner of the nib's head. In designing the letters of our font, the connections are formed of one cubic Bézier

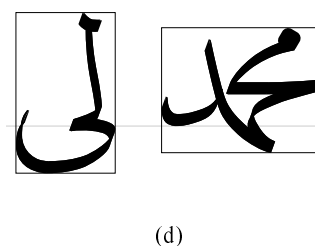
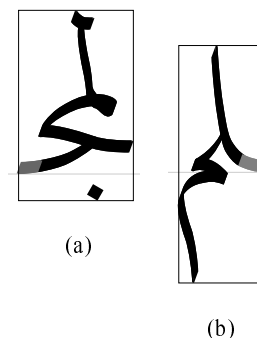

Figure 30. a) Compound letter with horizontal succeeding connection, b) Compound letter with horizontal preceding connection, c) Compound letter with horizontal succeeding connection and preceding connection, d) Compound letters as standalone letters.

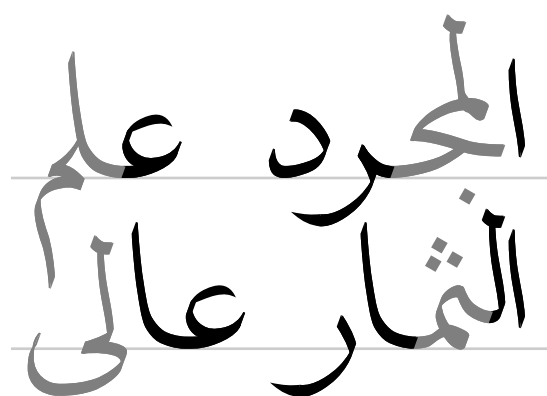

Figure 31. Contribution of compound letters as simple ones in words

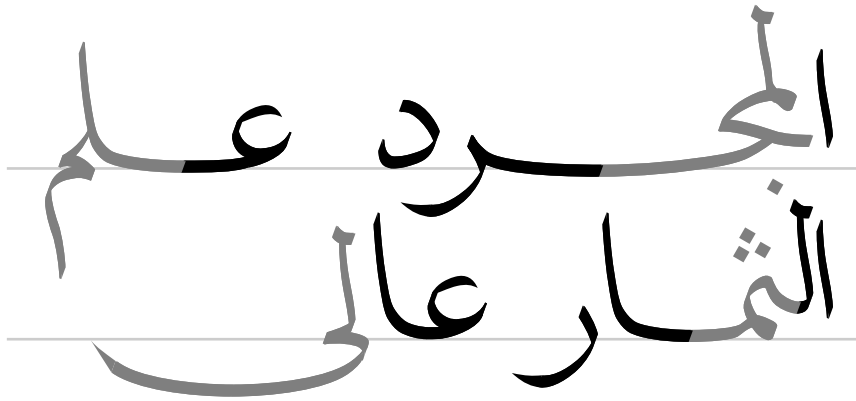

Figure 29. Contribution of compound letters in stretching

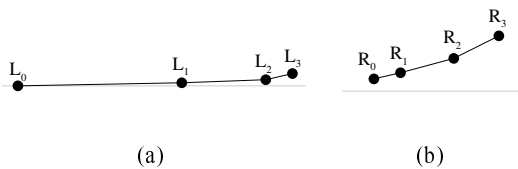

Figure 32. a) Oblique preceding connection, b) Oblique succeeding connection

curve. In the following, we suppose that the preceding connections have L_0, L_1, L_2 and L_3 as control points whereas, the succeeding connections have R_0, R_1, R_2 and R_3 as control points. There are various kinds of horizontal connections. A lot of them are, in general, not respected for reasons of simplification when that is not due to ignorance. Horizontal connections can be one of the five kinds :

- *Oblique connection* : in the figure 32 are presented in the left a preceding connection and in the right a succeeding one. These connections are oblique because the segments $[L_2, L_3]$ and $[R_0, R_1]$ are not parallel to the baseline.
- *Horizontal connection big-strictly above the baseline* : a connection is horizontal *big-strictly above* the baseline when the segment $[L_2, L_3]$ for the preceding connection and segment $[R_0, R_1]$ for the succeeding connection are parallel to the baseline and over it about one and 0.54 diacritic Point (see figure 33).
- *Horizontal connection strictly above the baseline* : the connections presented in the figure 34 are horizontal *strictly above* the baseline because the segments $[L_2, L_3]$ and $[R_0, R_1]$ are parallel to the baseline and over it about a half of a diacritic point (0.55 precisely).

Figure 33. a) Horizontal preceding connection *big-strictly above* the baseline, b) Horizontal succeeding connection *big-strictly above* the baseline

Figure 34. a) Horizontal preceding connection strictly above the baseline, b) Horizontal succeeding connection strictly above the baseline

- *Horizontal connection exactly on the baseline* : in this case $[L_2, L_3]$ and $[R_0, R_1]$ are exactly on the baseline as in the figure 35.

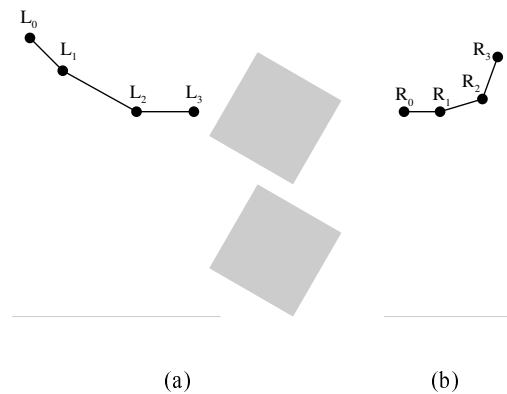
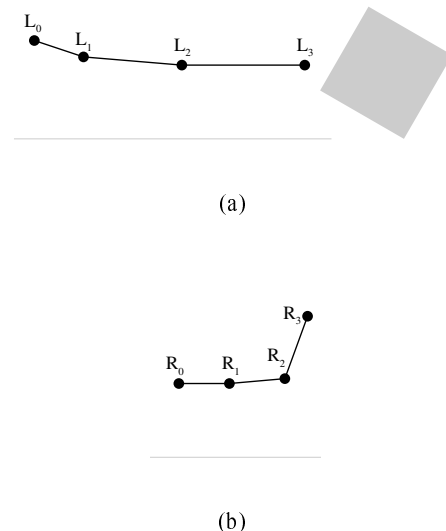
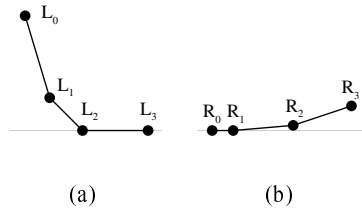

Figure 35. a) Horizontal preceding connection exactly on the baseline, b) Horizontal succeeding connection *exactly on* the baseline

- *Horizontal connection below the baseline* : $[L_2, L_3]$ and $[R_0, R_1]$ are parallel to the baseline and below it, about an amount that goes from zero to a half of diacritic point. In general, the depth of this connection depends on its width. These connections are used in certain cases of the keshideh. An example is given in the figure 36.

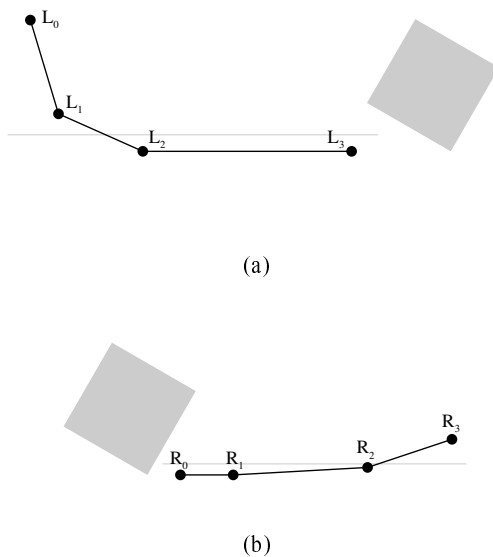

Figure 36. a) Horizontal preceding connection Below the baseline, b) Horizontal succeeding connection below the baseline

Now, we can define what does *horizontal ligature* means geometrically. An horizontal ligature is a combination of two horizontal connections C_1 and C_2 such that :

- C_1 and C_2 are of the same kind (oblique, big strictly above the baseline, ... etc.),
- C_1 is a preceding connection,

- C_2 is a succeeding connection and
- if L_0, L_1, L_2 and L_3 are the control points of C_1 , and R_0, R_1, R_2 and R_3 are control points of C_2 then L_3 and R_0 coincide and, L_2, L_3 and R_1 are aligned.

Note that the kind of the ligature is entirely determined by the kind of its connections. So, there are five kinds of horizontal ligatures. A font respecting a minimum of the Naskh calligraphic rules may support at least the *horizontal connections (ligatures) exactly on the base line and below the baseline*. The connections below the baseline are used in to stretch. We can state that these two kinds of horizontal ligatures are mandatory whereas other horizontal and vertical ligatures are rather aesthetic. However, Arabic handbooks calligraphy show more aesthetic ligatures than mandatory ones. That's one of the motivations behind the design of a font that allow producing documents closer to handwritten texts. The horizontal *oblique connections big strictly above the baseline, strictly above the baseline and strictly bellow the baseline* are not supported in [18, 8, 4, 31].

4. Model and support of the keshideh in Arabic calligraphy

4.1 Keshideh: the mathematical model

In this sub-section, we give the geometrical representation and processing of the curvilinear stretching. In order to present how to handle geometrically the keshideh, we'll first define the way of stretching some particular curves that constitute basic elements of the keshideh. Consider the following notations :

- The notation $[M_0, M_1, M_2, M_3]$: is the Bézier curve with control points M_0, M_1, M_2 and M_3 ,
- The set \mathcal{B}_1 : is the set of Bézier curves $[M_0, M_1, M_2, M_3]$ with an invariant concavity verifying:

$$\overrightarrow{M_2M_3} = \lambda \vec{i}, \lambda \in \mathbb{R}_+^* \text{ and } 0 \leq \widehat{(\overrightarrow{M_0M_1}, \vec{i})} \leq \frac{\pi}{2},$$

(see figure 37), where \vec{i} is the axis X director vector and $\widehat{(\vec{u}, \vec{v})}$ stands for the angle between the two vectors \vec{u} and \vec{v} .

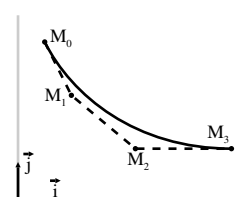

Figure 37. Curves of type 1 (in \mathcal{B}_1)

- The set \mathcal{B}_2 : is the set of Bézier curves $[M_0, M_1, M_2, M_3]$ with an invariant concavity verifying:

$$\overrightarrow{M_0M_1} = \lambda \vec{i}, \lambda \in \mathbb{R}_+^* \text{ and } 0 \leq \left(-\vec{i}, \widehat{M_3M_2} \right) \leq \frac{\pi}{2} \text{ (see figure 38).}$$

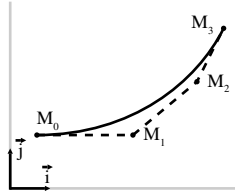

Figure 38. Curves of type 2 (in \mathcal{B}_2)

The keshideh is a juxtaposition of two Bézier curves, B_1 from the set \mathcal{B}_1 and B_2 from the set \mathcal{B}_2 . If L_0, L_1, L_2 and L_3 are the control points of B_1 and R_0, R_1, R_2 and R_3 are the control points of B_2 then L_3 and R_0 are equal. The keshideh's stretching results from the definition of the functions that stretch curves in \mathcal{B}_1 and \mathcal{B}_2 . So, we give the definition of two stretching functions E_{be} that stretches curves in \mathcal{B}_1 and E_{af} that stretches curves in \mathcal{B}_2 as follows. Let E_{be} be the stretching function defined by:

$$E_{be} : \mathcal{B}_1 \times [0, h_m] \times [0, v_m] \rightarrow \mathcal{B}_1$$

$$(B, h, v) \mapsto E_{be}(B, h, v)$$

The transformation E_{be} stretches curves in \mathcal{B}_1 . The details of its definition are given below :

Let $B_1 = [M_{10}, M_{11}, M_{12}, M_{13}]$ and $B_2 = [M_{20}, M_{21}, M_{22}, M_{23}]$ be two curves in \mathcal{B}_1 .

Let $(h, v) \in [0, h_m] \times [0, v_m]$. h stands for the horizontal stretching amount whereas v is the vertical one.

Definition 1 (E_{be} transformation).

$B_2 = E_{be}(B_1, h, v)$ if and only if the control points of B_2 are :

$$M_{20} = M_{10} - (h, 0)$$

$$M_{23} = M_{13} - (0, v)$$

$$M_{21} = (1 - c_1) M_{20} + c_1 J$$

$$M_{22} = (1 - c_2) J + c_2 M_{23}$$

With $c_1, c_2 \in [0, 1]$ satisfying :

$$M_{11} = (1 - c_1) M_{10} + c_1 I \text{ and}$$

$$M_{12} = (1 - c_2) I + c_2 M_{13}$$

Where

$$\{I\} = (M_{10}M_{11}) \cap (M_{12}M_{13})$$

and

$$\{J\} = \Delta_1 \cap \Delta_2 \text{ with}$$

Δ_1 : the parallel to $(M_{10}M_{11})$ passing through the point M_{20} .

Δ_2 : the parallel to $(M_{12}M_{13})$ passing through the point M_{23} .

An example of a stretching using the function E_{be} is presented in the figure 39.

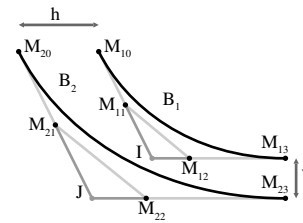

Figure 39. Stretching a curve belonging to the set \mathcal{B}_1 with E_{be} ($E_{be}(B_1) = B_2$)

Now, we have a function that allows stretching a curve belonging to the set \mathcal{B}_1 , what about curves in \mathcal{B}_2 ?

Let E_{af} be the stretching function defined as follows:

$$E_{af} : \mathcal{B}_2 \times [0, h_m] \times [0, v_m] \rightarrow \mathcal{B}_2$$

$$(B, h, v) \mapsto E_{af}(B, h, v)$$

The details of the definition of E_{af} are :

Let $B_1 = [M_{10}, M_{11}, M_{12}, M_{13}]$ and $B_2 = [M_{20}, M_{21}, M_{22}, M_{23}]$ be in \mathcal{B}_2 .

Let $(h, v) \in [0, h_m] \times [0, v_m]$.

Definition 2 (E_{af} transformation).

$B_2 = E_{af}(B_1, h, v)$ if and only if the control points of B_2 are :

$$M_{20} = M_{10} - (h, v)$$

$$M_{23} = M_{13}$$

$$M_{21} = (1 - c_1) M_{20} + c_1 J$$

$$M_{22} = (1 - c_2) J + c_2 M_{23}$$

With $c_1, c_2 \in [0, 1]$ satisfying :

$$M_{11} = (1 - c_1) M_{10} + c_1 I$$

$$M_{12} = (1 - c_2) I + c_2 M_{13}$$

Where

$$\{I\} = (M_{10}M_{11}) \cap (M_{12}M_{13}) \text{ and}$$

$$\{J\} = \Delta_1 \cap \Delta_2$$

with

Δ_1 : is the parallel to $(M_{10}M_{11})$ passing through the point M_{20} .

Δ_2 : is $(M_{12}M_{13})$.

As for the function E_{be} , an example of stretching with the function E_{af} is given in the figure 40.

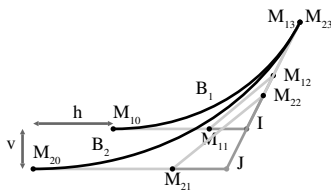

Figure 40. Stretching a curve belonging to the set B_2 with E_{af} ($E_{af}(B_1) = B_2$)

Now, consider a set of curves C (see figure 41) to be stretched. More exactly, the stretching will be done with a keshideh modeled with the curves B_{11} and B_{21} . Consider the following curves :

C_1 : a curve bound to the left of B_{11} (see figure 41),

C_2 : a curve bound to the right of B_{21} .

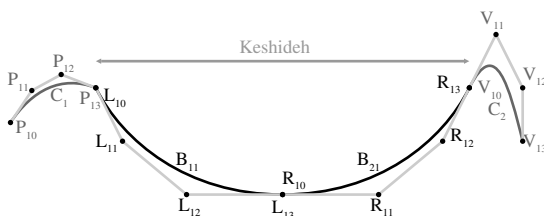

Figure 41. initial state of a set of curves C to be stretched

The stretching or the keshideh with regard to h horizontally and v vertically results from the following transformations :

- $E_{af}(B_{21}, \frac{h}{2}, v)$ to get B_{22} (see figure 42),

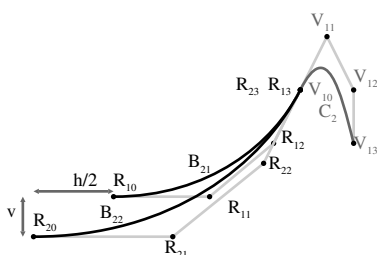

Figure 42. Stretching the curve B_{21} of $\frac{h}{2}$ and v

- $t_{\vec{u}}(B_{11})$ to get B'_{11} , where $t_{\vec{u}}$ is a translation of vector $\vec{u} = (-\frac{h}{2}, 0)$ (see figure 43),

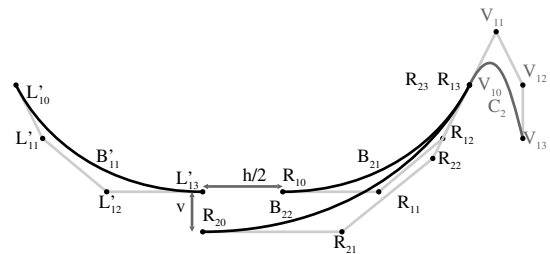

Figure 43. Translation of B_{11} towards the right-side of $\frac{h}{2}$

- $E_{be}(B'_{11}, \frac{h}{2}, v)$ to have B_{12} (see figure 44)

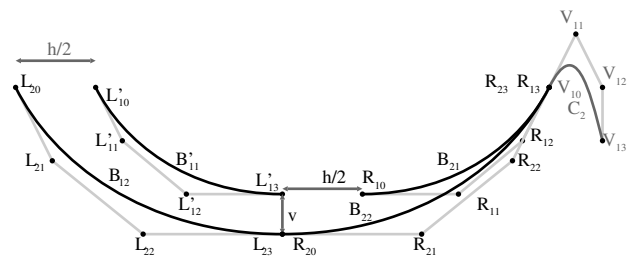

Figure 44. Stretching the curve B'_{11} of $\frac{h}{2}$ and v

- $t_{\vec{v}}(C_1)$ to have C'_1 , where $t_{\vec{v}}$ is a translation of vector $\vec{v} = (-h, 0)$ (see figure 45).

After all these transformations, the set of curves C gives a stretching as in the figure 46.

In the PostScript encoding, not all these transformations are to be handled explicitly. In some cases, some of them (some translations) are automatically processed with the PostScript interpreter. We remark that before stretching, R_{12} , R_{13} and V_{11} are aligned. After the stretching R_{22} , R_{23} and V_{11} are aligned too. The angles $(L_{10}P'_{12}, L_{10}L_{11})$ and $(L_{20}P'_{12}, L_{20}L_{21})$ are equal. The derivatives of degree 0 and 1 are preserved in the points where the keshideh is connected to other curve sets.

4.2 Keshideh: The support in the font

As it has been said before, the keshideh is a small flowing curve that stretches and/or connects Arabic letters. Even though it is not a character it is supported as parts of the stretched letters. And, as it has also been said before, the stretching can appear inside a letter or between two connected letters (see figure 4). When a word, in a text, is to be stretched, if the last letter of this word

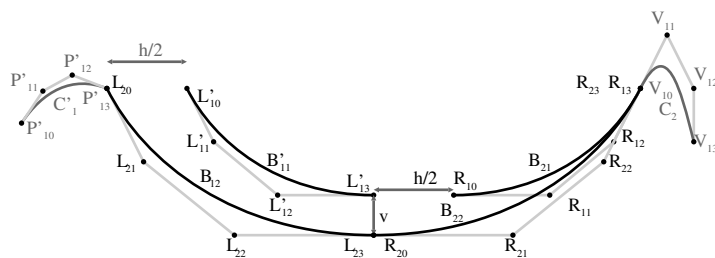
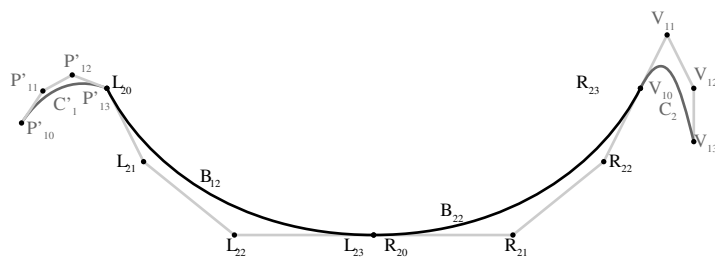
Figure 45. Translation of C_1 towards the right direction in h Figure 46. The set C after stretching of h and v

is a stretchable one, the stretching occurs in this letter otherwise the stretching will be in the ligature between the two last connected letters of the word. The two cases are presented separately in the following.

4.2.1 Inter-letters keshideh

The keshideh is a juxtaposition of two curves of type 1 and type 2. When the keshideh appears between two connected letters, the first curve is the horizontal preceding connection below the baseline of the letter in the left and the second part of the keshideh is the horizontal succeeding connection below the baseline of the letter in the right. When we designed the font, we parameterized the horizontal connections exactly on the baseline in a way such that they can be stretched horizontally to the right and vertically downwards. So, when the stretching is null, the connections are simply those exactly on the baseline, otherwise they are horizontal strictly below the baseline. From now, we mean by parameterized horizontal connection exactly on the baseline a connection that support the connection exactly on the baseline and below the baseline. For example, when the word ظفر is to be stretched, the stretching occurs between the letters ز and ر. The letters ز and ر have horizontal connections exactly on the baseline that are parameterized to support stretchability. Then, the Stretching consists on keeping the word as it is and communicating a horizontal and vertical amounts of stretching as parameters to the procedures for writing these two letters. Suppose that we want to stretch the word ظفر of an amount h horizontally and v vertically downwards, then, we have to

perform the two actions :

- to stretch the horizontal succeeding connection of the letter ز of $\frac{h}{2}$ horizontally and v vertically and
- to stretch the horizontal preceding connection of the letter ر of $\frac{h}{2}$ horizontally and v vertically.

In the figure 47, an illustration of a stretching in a font size equal to 64 points is given. In the first line, the word ظفر with a null stretching is presented. In the last line, the same word is stretched 12 dp (diacritic point) horizontally and 0.5 dp vertically. In the second line the letters ز and ر in their initial shapes are showed whereas in the third line, both of the two letters have a stretching of 6 dp horizontally and 0.5 dp vertically.

Most of the handbooks of calligraphy [3, 22, 25], teach that : in the beginning of a word in Arabic letters, the commonly used horizontal connections are oblique, big strictly above the baseline and strictly above the baseline. That's an aesthetic need. When we have to write the word formed of the letters BEH in initial position and AIN in the end without stretching, a letter BEH and AIN with horizontal succeeding connection and preceding connection respectively strictly above the baseline are used. Let بع be such a word (the word to the right on the figure 48), when a stretching is needed, the alternatives of these two letters with horizontal connections below the baseline (they are horizontal connections exactly on the baseline when the amount stretching is null) are used. In this way, the word بع would be used. The two alternatives of the word are in clear on the figure 48.

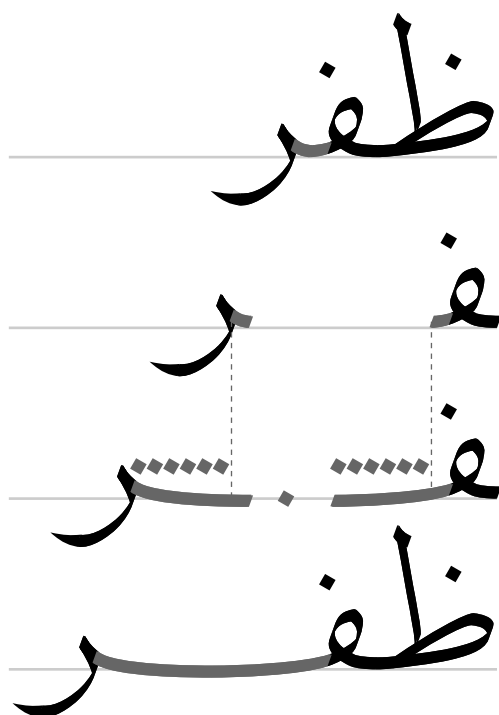

Figure 47. Inter-letters keshideh mechanisms

We can introduce these alternatives in the font to solve the problem of stretchability needs so that the texts processed with the font satisfies the Calligraphic rules. Of course, these alternatives are allowed by the Calligraphic rules and exist. Consider the word ظ , the letter ظ admits an horizontal connection after *exactly* on the baseline because ظ is a strongly rising letter from the baseline. It is the same for the letter ع that admits a preceding connection exactly on the baseline. It is mandatory in a situation such as after the letter ط in the word اطع or after ع inside the word نفع . We can apply the alternatives of letters also when the ligature is oblique, in the case of a null stretching. But it doesn't work in some particular situations such that concerning the stretching of the word خط . Stretching the ligature between the two letters of the word خط has been handled in a particular way. Indeed, when some characters such as ظ (or its variants) are in initial position and that they are followed by TAH in final position ط (or its variants), the connections are *oblique* and then, stretching through using the alternative of the letter KHAH and TAH with parameterized horizontal connections exactly on the base line gives a bad result in comparison with the handwritten proof. It took a lot of time to find a solution to this case. It reminds the case where D.E. Knuth spent a lot of time modeling mathematically the letter S in Metafont. The cases are not analogous, technically saying, but in difficulties to find a solution they are. A method to find a solution to this case consists on including the stretching inside



Figure 48. Useful alternatives to stretch

the character TAH. We developed an alternative of the TAH in final position with a connection before consisting of two Bézier curves B_l in \mathcal{B}_1 with control points L_0, L_1, L_2 and L_3 on the left, followed by another Bézier curve B_r in \mathcal{B}_2 with control points R_0, R_1, R_2 and R_3 on the right such L_3 coincides with R_0 . Let ط be that alternative (see figure 50), the keshideh will then be the combination of these curves and there is precisely the place where stretching will take place (see figure 51, the first occurrence of the word in the right is with oblique connections). We conclude that to stretch the word خط , we may keep the letter ظ without changes and replace the letter ط (see figure 49) by ط (see figure 50) and then, the stretching can be performed. With this alternative the stretching of the word خط has been appreciated by a calligrapher and became good in comparison to the handwritten proof.

Figure 49. TAH in final position with *oblique* preceding connection

Figure 50. Alternative for stretching the character TAH in final position preceded by HAH in initial position

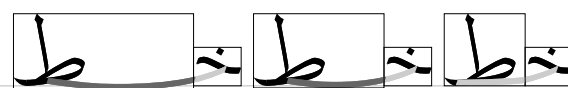

Figure 51. Stretching in the level of TAH

4.2.2 The intra-letter keshideh

When the keshideh is inside a character, say for instance, into the letter QAF, in final position of the word حق , according to the Arabic calligraphy rules, the letter QAF admits an horizontal stretching between 9 and 12 diacritic

points. The shape of the letter QAF ق without stretching is quite different from the stretched one, the character ق is only a variant of ق. So, it has the same width of ق increased of 9 diacritic points. It also has the same depth as ق increased of the vertical downward stretching corresponding to the horizontal stretching of 9 diacritic points. To compute the stretching, the letter ق is used and can be stretched horizontally between zero and three diacritic points. The vertical stretching varies in the range corresponding to the horizontal extension from zero to three diacritic points. The keshideh is performed inside ق. The part modeling the keshideh is displayed in gray on the figure 52. The letter QAF in final position is in font size 128 points. The control points of the left bottom corner of the nib's head are given to make it more understandable.

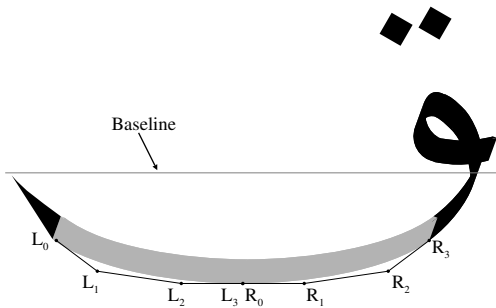

Figure 52. The keshideh in the letter QAF in final position

In the development of our PostScript font, the horizontal stretching is a value communicated to character procedures as a global variable h . As in [8], at the end of each call of procedure, the value of h is put back to zero. The value h is determined by means external to the font, such as the text formatting programs. Then it is communicated to the character procedures in the font. The vertical stretching v is determined from the horizontal stretching in the font through the simple function φ defined in the following :

- h : value of horizontal stretching (towards the right direction),
- v : value of vertical stretching corresponding to h (downward), v depends on h , so we can write $v = \varphi(h)$ where φ is defined by :

$$\varphi : [0, h_m] \rightarrow [0, v_m]$$

$$h \mapsto \frac{v_m}{h_m} h$$

- h_m : maximal value of horizontal stretching,
- v_m : maximal value of vertical stretching.

With regard to the definition of the function φ , the curvilinear stretching functions E_{af} and E_{be} defined above can be regarded as linear scaling, but they are not so.

4.3 The nib's head motion modeling approach versus other approaches

In this sub-paragraph, the approach for modeling of the nib's motion is compared in one hand to the Knuth's approach in Metafont [10] and to the Kinch's one in MetaFog [28] in the other hand. These two approaches seek the envelope of an ellipse stroking (a nib with an elliptic head) in two different ways. The Knuth's approach follows the Hobby method [16] to represent the envelope in terms of the raster instead of scalable curves. Kinch solve the problem through representing the envelope in an algebraic and topological way. In our approach, the envelope of the characters static parts is determined using tools outside the PostScript interpreter. A specific program (based on a mathematical idea presented in the sub-paragraph 2.4) helps to determine this envelope. Of course, we also can use Metapost [17], to determine the envelope and cope with other programs to eliminate the fact that some zones are painted twice. The characters static parts have *true* outlines (there are no overlapping curves), the envelope is generated as with MetaFog. Concerning the characters dynamic parts, such as the parts of the keshideh, the envelope is determined in a way different from the Knuth's and Kinch's approaches. In order to well explain and justify our approach, let us consider a left component of a keshideh (see figure 53).

The curve B_1 of type 1 in the figure 53 has the control points (169,205), (170,151), (249,134) and (340,134). The nib's head width and thickness are 31.9643 and 15.9821 points respectively. Here, we have considered a thickness equal to half of the width for clarity. The points where the slopes are parallel to the vectors defining the nib when the thickness is a sixth of the width are the same. The vectors \vec{u}_1 , \vec{u}_2 and \vec{u}_3 are respectively (10.9177,30.042), (-4.10678,35.4913) and (-15.0244,5.44933). $B_1'(t)$ is parallel to \vec{u}_2 at 0.0323 and to \vec{u}_3 at 0.4923. After applying a stretching with the E_{be} to B_1 with an horizontal stretching equal to 109.1601 points and a corresponding vertical one 9.0966 points, we obtain the curve B_2 with the control points (59.8398972,205), (60.9680176,144.081482), (190.549225,124.903397) and (340,124.903397). Then $B_2'(t)$ is parallel to \vec{u}_2 and \vec{u}_3 at 0.0224 and 0.3980 respectively. The coefficients where the slopes are parallel to the vectors of the nib's head change from a stretching state to another. The reason for this is simply that the functions of stretching used to compute the keshideh are not a *linear scaling*. In order to determine these coefficients and therefore, to be able to determine the envelope as the Kinch's approach seek through computing these coefficients in the PostScript character procedure. Then, printing the character will be very slow. To avoid such problem, we opt for painting the surface razed with ev-

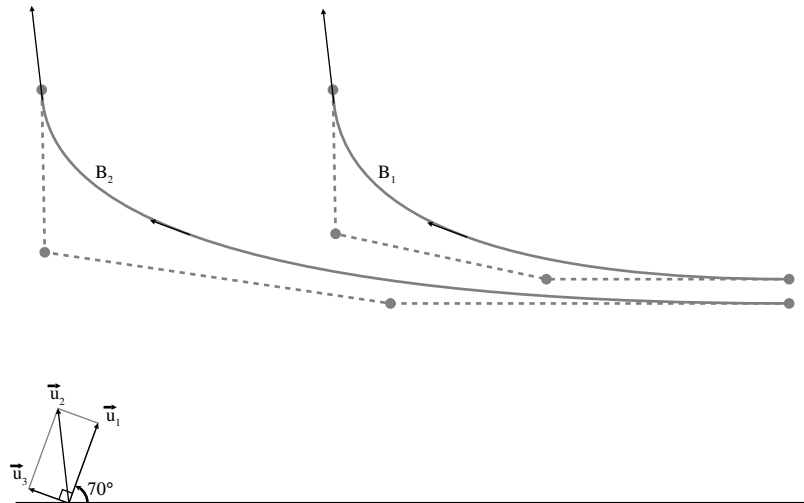

Figure 53. Identification of points where slopes are parallel to vectors defining the nib's head

ery edge of the nib's head. So, some parts are painted twice or more causing a larger CPU time consuming but it is still less than the time used to compute the outlines of the curve. As we have seen before, some parts of the surface razed with the nib's head can be lost in the neighborhood of the points where the slopes are parallel to the vectors \vec{u}_2 and \vec{u}_3 . In the figure 54, the real surface razed with the nib's head according to the curve B_1 is showed. Whereas, in the figure 55, we have drawn the surface that is on the figure 54 and then drawn the envelope (in gray) with our adopted technique on it. We remark that we can not distinguish the lost zones (that must be in black). The reason is that the keshideh curves have curvature vectors [6] with small magnitudes (Or the radiuses of the osculating circles are big) especially on the points where the derivative is collinear to \vec{u}_2 and \vec{u}_3 . We can accept then this inaccuracy because the results are considered more in their visual aspects. Reeves [32] call this phenomenon "Visual Accuracy". When we consider a nib's head that respect the ratio existing between the width and the thickness of the nib's head (one a sixth) the result would be more satisfying visually.

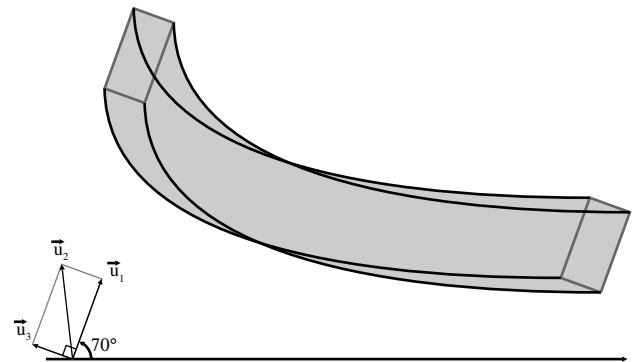

Figure 55. The razed surface with our approach

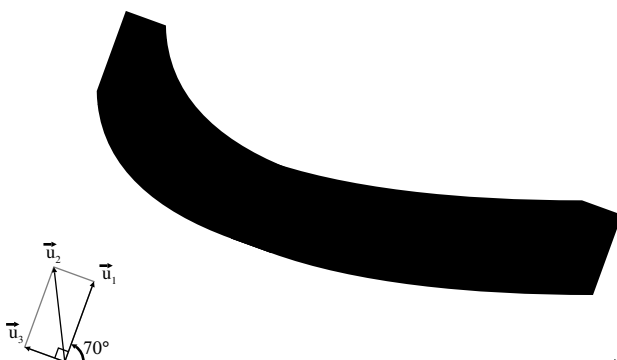

Figure 54. The real razed surface

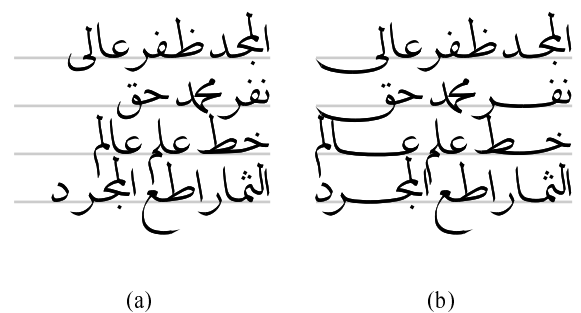

Figure 56. a) Arabic text lines before justification, in 18 pt, b) Arabic text lines after justification.

5. Conclusion and perspectives

Our main goal consisted on designing a font that helps in producing Arabic documents looking like handwritten proof. So, it was necessary to identify all kinds of ligatures and to introduce keshideh in an adequate way. We were brought to scan the handwritten proofs and then to work on these proofs with simple graphic tools

like Kontour [19] under Linux [24], in order to get the encoding of the letters in terms of Postscript Bézier's curves. The existing font tools were not enough to take into account the motion of the nib's head, the metrics in diacritic point, the possibility to correct some errors allowed for the calligrapher in handwritten proofs etc. We worked almost manually to design the PostScript encoding of some characters that represent most of the cases and we got so a *mini-font*. This font has been used to give the example in the figure 56. This is a set of lines (with no meaning in Arabic) to assess justification through keshideh. The requirements, support and development of a tool to assist in designing Arabic fonts should be a separate work. In any way, there will be no satisfying compromise to respect the rules of Arabic calligraphy unless a geometrical model for all the characters and symbols is built.

References

- [1] Adobe Systems Incorporated, *Adobe Type 1 Font Format*, Part No. LPS0064, 1990.
- [2] Adobe Systems Incorporated, *PostScript Language Reference Manual*, MA:Addison-Wesley, Third edition, Massachusetts, 1999.
- [3] Ahmed El Houssaini, *The Arabic Calligraphy*, Dar Attaila, 1994.
- [4] Azzeddine Lazrek, "A package for typesetting Arabic mathematical formulas", *Die T_EXnische Komodie*, DANTE e.V., Vol.13, No. 2, pp. 54-66, 2001.
- [5] Azzeddine Lazrek, "CurExt, Typesetting variable-sized curved symbols", *EuroT_EX 2003 Pre-prints : 14th. European T_EX conference*, Brest, France, pp. 47-71, 2003.
- [6] Brian A. Barsky, *The Beta-splines : A Local Representation Based on Shape Parameters and Fundamental Geometric Measures*, Department of Computer science, Ph.D. dissertation, University of Utah Salt Lake City, December 1981.
- [7] Brian A. Barsky, *Arbitrary Subdivision of Bézier Curves*, Technical Report UCB.CSD 85/265, Computer Science Division, University of California, 1985.
- [8] Daniel M. Berry, "Stretching Letter and Slanted-Baseline Formatting for Arabic, Hebrew and Persian with ditroff/fforttid and Dynamic PostScript Fonts", *Software-Practice and Experience*, vol. 29, no. 15, pp.1417-1457, 1999.
- [9] D.E. Knuth, *The T_EXBook, Computers and Typesetting*, Reading MA : Addison-Wesley, Vol.A, 1984.
- [10] D.E. Knuth, *The MetafontBook, Computers and Typesetting*, MA: Addison-Wesley, Vol.C, 1986.
- [11] D. Weise, D. Adler, *TrueType and Microsoft Windows 3.1*, Technical Report, Microsoft Corporation, Redmond, WA, 1992.
- [12] Jacques André, B. Borghi, "Dynamic Fonts", *PostScript Language Journal*, Vol 2, no 3, pp. 4-6, 1990.
- [13] Jacques André, Irène Vatton, *Contextual Typesetting of Mathematical Symbols Taking Care of Optical Scaling*, Technical report No 1972, INRIA, October 1993.
- [14] Jacques André, Irène Vatton, "Dynamic Optical Scaling and Variable-sized Characters", *Electronic Publishing*, Vol 7, No 4, pp. 231-250, December 1994.
- [15] Jeffrey M. Lane, Richard F. Riesenfeld, "Bounds on Polynomial", *BIT*, Vol 21, No 1, pp. 112-117, 1981.
- [16] John Douglas Hobby, *Digitized Brush Trajectories*, Ph.D. Thesis, Department of Computer sciences, Stanford University, August 1985.
- [17] John Douglas Hobby, *A User's manual for MetaPost*, Technical Reports Report, AT& T Bell Laboratories Computing Science 162, 1992.
- [18] Klaus Lagally, *ArabT_EX User Manual*, Universitat Stuttgart, Fakultat Informatik, Version 4.00, 2004.
- [19] KOffice. 'Kontour : Koffice drawing tool', <http://www.koffice.org/Kontour>, 2001.
- [20] Leslie Lamport, *L^AT_EX-A Document Preparation System*, Reading MA: Addison Wesley, 1985.
- [21] LyX Team, *The LyX User Manual*, <http://www.LyX.org>, Version 1.3.4, 2004.
- [22] Mahdi Essaid Mahmoud, *Learning Arabic Calligraphy : Naskh, Roqaa, Farsi, Thuluth, Diwany'*, Ibn Sina publisher, Cairo- Egypt, 1994.
- [23] Mamoru Hosaka, Fumihiko Kimura, "A Theory and Methods for Free Form Shape Construction", *Journal of Information Processing*, Vol 3, No 3, pp. 140-151, (1980).
- [24] Mandrake Soft, *Mandrake Linux 8.2*, <http://www.mandrakeSoft.com>, 2002.
- [25] Mohammed Hachem El Khattat, *Arabic Calligraphy Rules, A Calligraphic set of Arabic Calligraphy Styles*, Books Univer, Beyrouth- Lebanon, 1986.
- [26] M. J.E. Benatia, M. Elyaakoubi, A. Lazrek, "Arabic Text Justification", *TUG 2006 Conference Proceedings*, Volume 27, No 2, pp. 137-146, 2006.
- [27] Mostafa Banouni, Mohamed Elyaakoubi, Azzeddine Lazrek, "Dynamic Arabic Mathematical Fonts", *Lecture Notes in Computer Science (LNCS)*, Springer Verlag, Volume 3130, pp. 158-168, 2004.
- [28] Richard J. Kinch, "MetaFog : Converting Metafont Shapes to Contours", *Preprint: Proceedings of the Annual Meeting*, pp:1001-1011, June 1996.
- [29] Ronald N. Goldman, "Using Degenerate Bézier Triangles and Tetrahedra to Subdivide Bézier Curves", *Computer-Aided Design*, Vol 14, No 6, pp. 307-311, November 1982.
- [30] Yannis Haralambous, "The Traditional Arabic Type-case Extended to the Unicode Set Of Glyphs", *Electronic Publishing*, Vol. 8, No. 2-3, pp. 111-123, 1995.
- [31] Yannis Haralambous, John Plaice, "Multilingual Typesetting with Ω , a Case Study : Arabic", *International Symposium on Multilingual Information Processing '97*, Tsukuba (Japan), pp. 137-154, 1997.
- [32] William T. Reeves, *Quantitative Representations of Complex Dynamic Shapes for Motion Analysis*, PhD thesis, University of Toronto, 1981.



Abdelouahad BAYAR is professor of mathematics and computer science at Cadi Ayyad University (école Supérieure de Technologie) in Safi, Morocco since 1996. He gets a CEUS (Certificat d'Etudes Universitaires Supérieures) in applied mathematics and computer science

in 1996. He integrates then the university as a research-teacher. He holds his Doctorat of the third cycle in 1999 in Computer science in communication networks. Since 2007, Bayar is a member of the group of Information Systems and Communication Networks LSNC in Information Systems Ingeniering Laboratory ISIL. His actual investigations deal especially with dynamic fonts and calligraphic rules formalization.



Khalid SAMI is professor of mathematics at Cadi Ayyad university (Faculté des Sciences) in Marakech, Morocco since 1983. Since years, he's intrested in multilingual scientific text formatting. Some of the work relevant to this area is presented in the url

www.ucam.ac.ma/fssm/rydarab.